

**FC-325**  
7,0 Kg

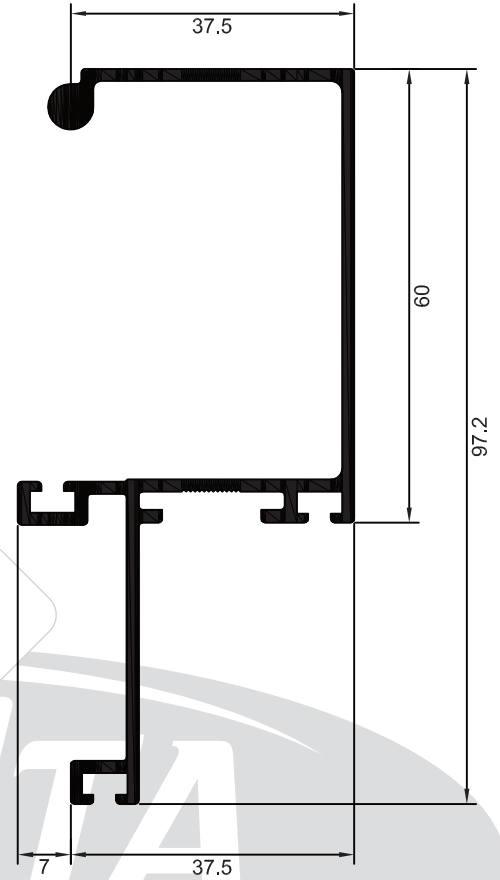

**FC-326**  
6,1 Kg

Aluminio Porto Alegre Ltda.

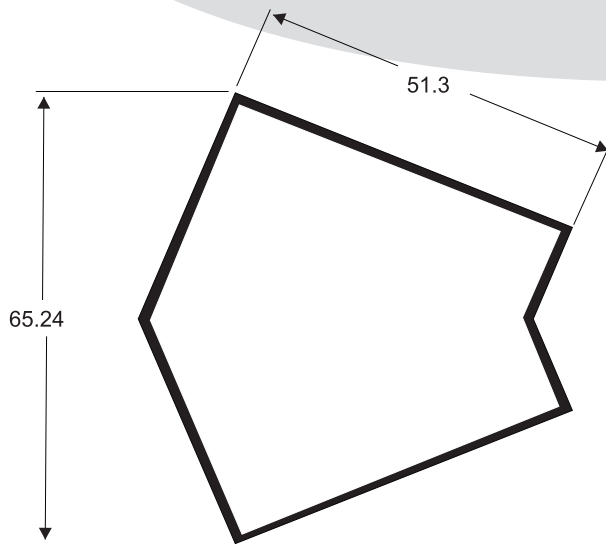

**FC-240**  
5,2 Kg (6,5m)

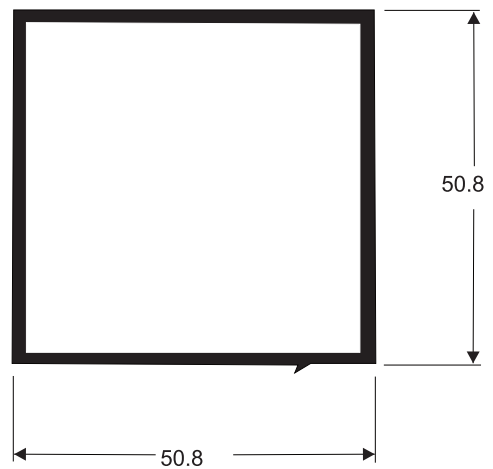

**TQ-017**  
6,5 Kg

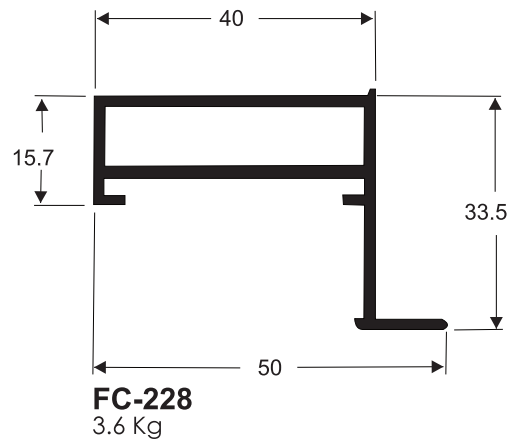
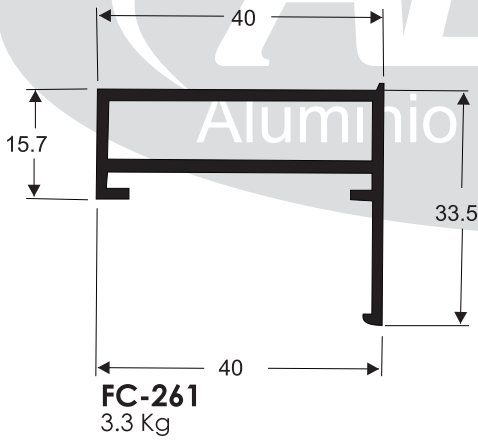
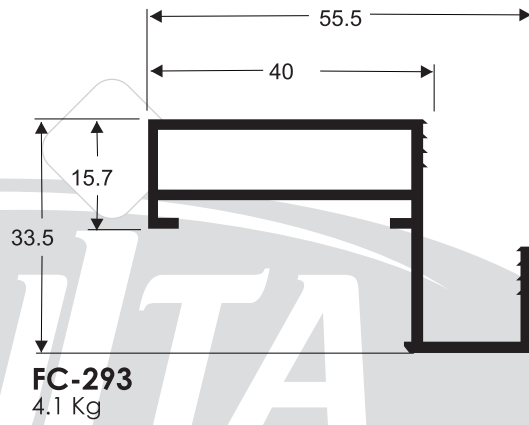
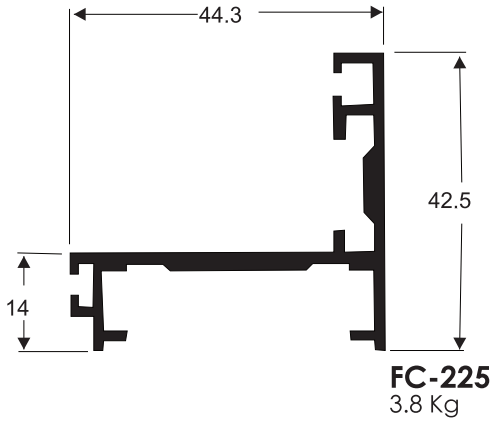

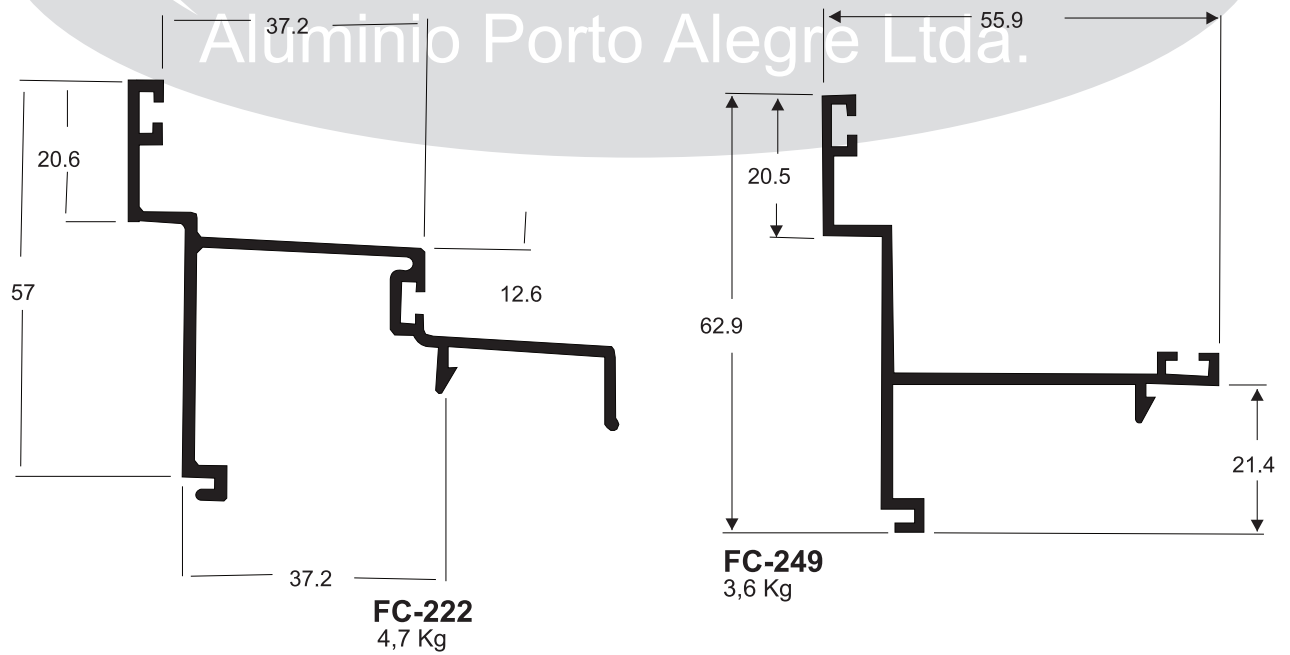
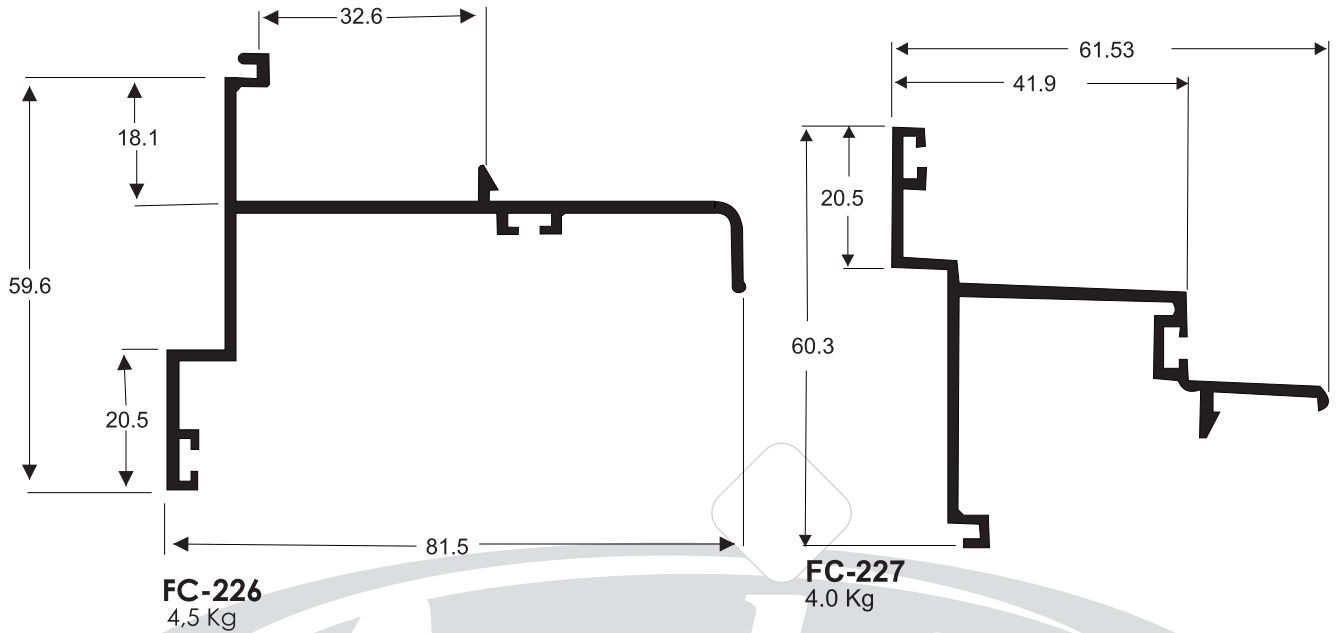

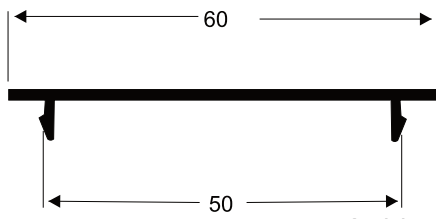

**FC-085**  
1,65 Kg

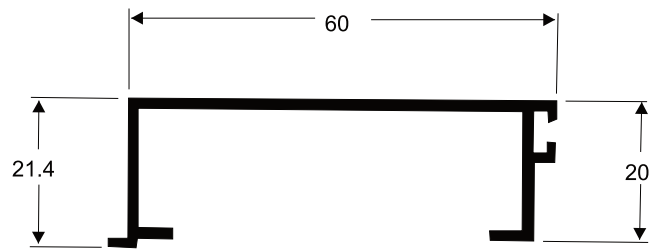

**FC-247**  
2,7 Kg

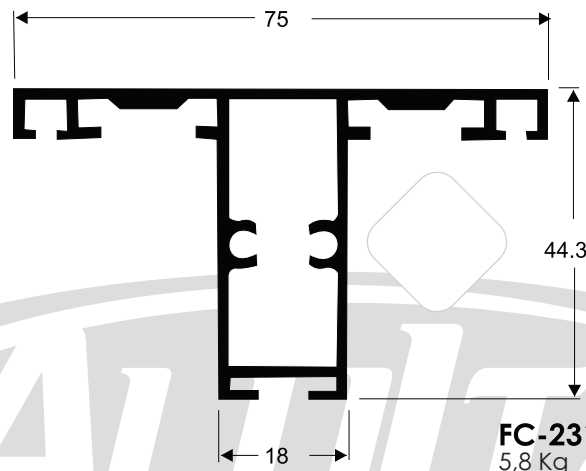

**FC-231**  
5,8 Kg

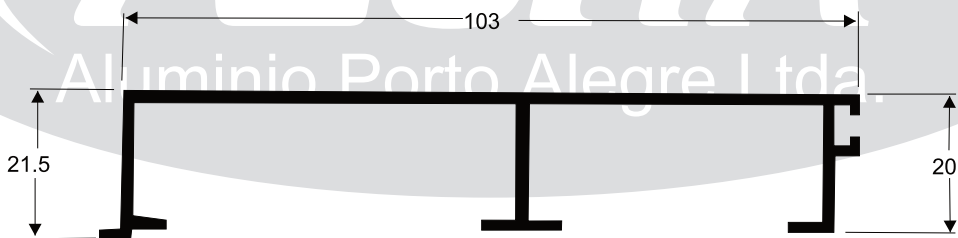

**FC-246**  
4,6 Kg

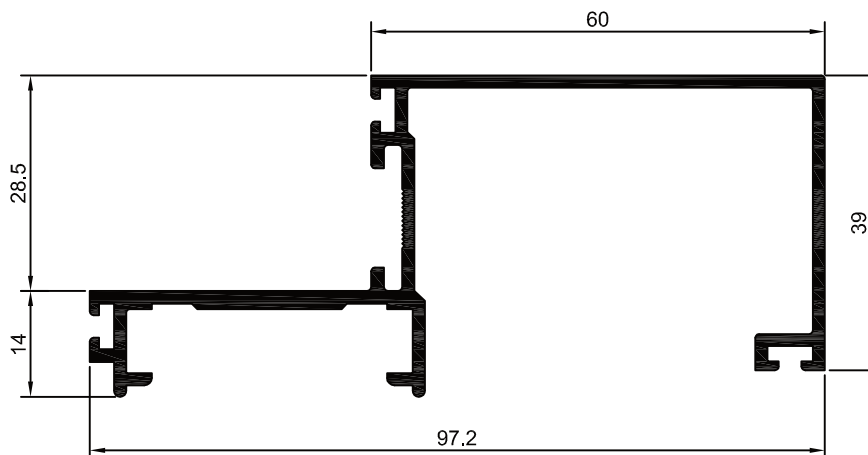

**FC-243**  
7,2 Kg (6,5m)

